

## TABLE MAGNIFIER WITH ILLUMINATION CODE 7517-3D

- Four steps brightness adjustment
- LED illumination, working life 20000h
- Resin lens

### SPECIFICATION

<b>Magnification</b>	1.75X
<b>Diopter</b>	3D
<b>Lens diameter</b>	Ø125mm
<b>Illumination</b>	power: 3W, illumination: 260lm
<b>Power supply</b>	power adapter 12V, 1A



## TABLE MAGNIFIERS WITH ILLUMINATION

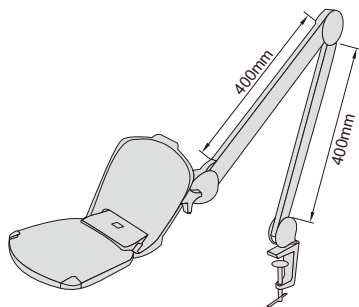

- LED illumination, working life 20000h
- Resin lens

### SPECIFICATION

Code	7520-320D	7521-3D
<b>Magnification</b>	two magnifications 1.75X/6X	1.75X
<b>Diopter</b>	3D/20D	3D
<b>Lens dimension</b>	160×127mm	Ø126mm
<b>Illumination</b>	power: 6W, illumination: 550lm	
<b>Power supply</b>	power adapter 12V, 1A	



## TABLE MAGNIFIER WITH ILLUMINATION CODE 7516-5D

- LED illumination, working life 20000h

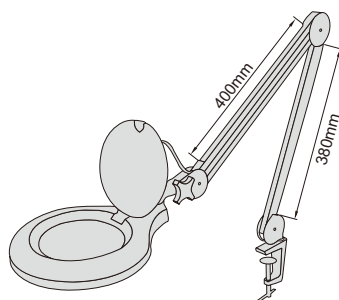

### SPECIFICATION

<b>Magnification</b>	2.25X
<b>Diopter</b>	5D
<b>Lens diameter</b>	Ø122mm
<b>Illumination</b>	power: 7W, illumination: 420lm
<b>Power supply</b>	100~240V, 50~60Hz



## FOLDING MAGNIFIER

- Glass lens

Code	Magnification	Lens diameter (ØD)
7511-8	10X	Ø21mm



7511-8

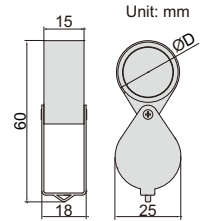

## FOLDING MAGNIFIER WITH ILLUMINATION

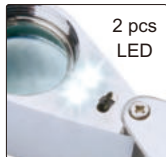

2 pcs LED

- Resin lens
- Powered by 3xLR927 batteries (included)

Code	Magnification	Lens diameter (ØD)
7515-10	10X	Ø21mm



7515-10

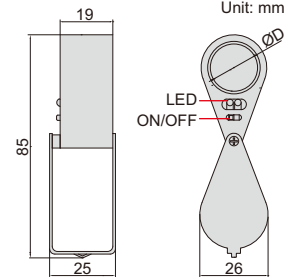

## FOLDING MAGNIFIER WITH ILLUMINATION

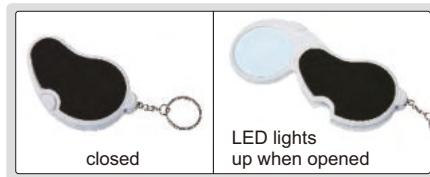

closed

LED lights up when opened

- Resin lens
- Powered by 2xCR1620 batteries (included)
- LED lights up automatically when opened

Code	Magnification	Lens diameter (ØD)
7514-1	2.5X	Ø45mm



7514-1

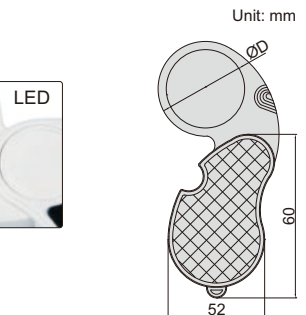

## MAGNIFIER WITH ILLUMINATION

- Glass lens
- Powered by 3xAG7 batteries
- 3 pcs LED and 3 pcs UV
- Base with scale, graduation: 0.5mm, 1/16"

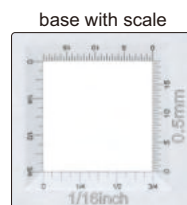

base with scale

rotate lens to adjust focus



7524-10

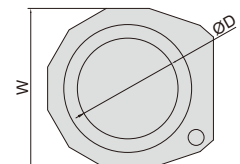
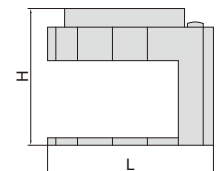

Code	Magnification	Lens diameter (ØD)	L	H	W
7524-10	10X	Ø30mm	60mm	50mm	56mm

## MAGNIFIERS WITH ILLUMINATION

- Glass lens
- Powered by 3xAAA batteries (included)



Code	Magnification	Lens diameter (ØD)	L	h
7513-2	2X	Ø75mm	170mm	90mm
7513-4	4X	Ø50mm	145mm	90mm

## MAGNIFIER WITH TWO LENSES

- Resin lens
- Interchangeable lenses
- Powered by 3 pcs AAA batteries (included)



Code	Lens number	Magnification	Lens diameter (ØD)
7522-610	2 pcs	6X	50mm
		10X	37mm

## MAGNIFIER WITH ILLUMINATION

- Two magnifications
- LED illumination
- Powered by 2 pcs AAA batteries (included)
- Resin lens



Code	Magnification	Lens size
7518-26	2X/6X	90x55mm

## MAGNIFIER WITH ILLUMINATION

- Handheld and desk-type use
- Two magnifications
- LED illumination
- Powered by 2xAA batteries (included)
- Resin lens



Code	Magnification	Lens diameter (ØD)
7519-26	2X/6X	90mm

### THREE WAYS MAGNIFIER WITH ILLUMINATION

- Resin lens
- Powered by 2xAA batteries (included) or power adapter (110~240V, 50~60Hz)

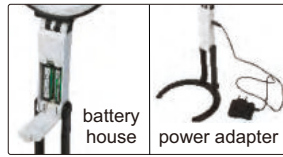

three ways use



Code	Magnification	Lens diameter (ØD/Ød)
7512-1	2X/4X	Ø120mm/Ø28mm

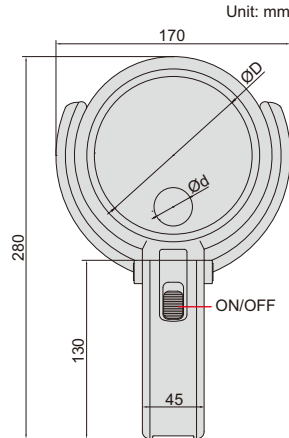

7512-1

### MAGNIFICATION GLASSES

interchangeable lenses



head band (included)



7523-3D5

adjustable lens and LED angle

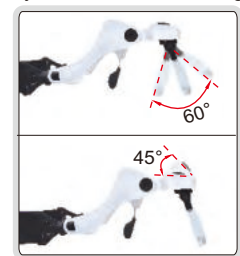

- Resin lens
- Interchangeable lenses
- Powered by 3 pcs AAA batteries (included)

Code	Lens number	Magnification
7523-3D5	5 pcs	1X
		1.5X
		2X
		2.5X
		3.5X

adjustable holder angle



moveable lens for focus



2 pcs LED



### TELESCOPING INSPECTION MIRRORS

- Inspect hidden areas
- Rotation of the mirror: 360°
- Length of handle is adjustable, handle is made of stainless steel

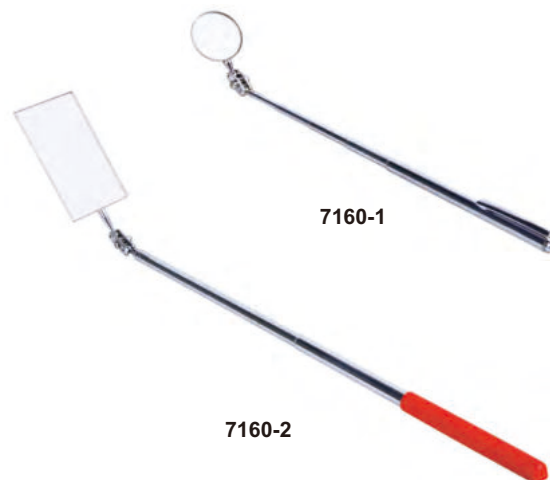

7160-1

7160-2

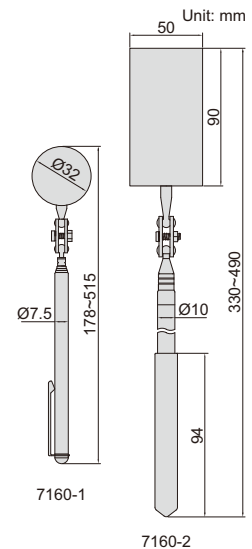

7160-1

7160-2

Code	Size of mirror	Length
7160-1	Ø32mm	178~515mm
7160-2	50x90mm	330~490mm

## TELESCOPING INSPECTION MIRROR (WITH ILLUMINATION)

- Inspect hidden areas
- Head can bend and rotate
- Telescoping handle, made of stainless steel
- With two CR2032 batteries

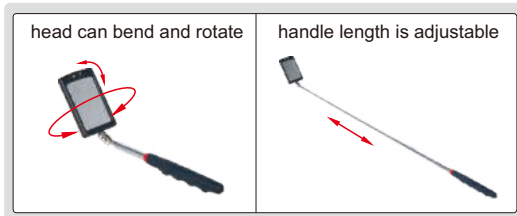

7162-1

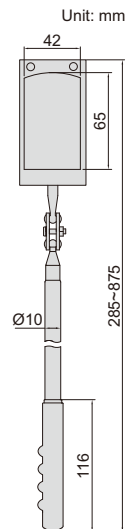

Code	Size of mirror	Length
7162-1	65x42mm	285~875mm

## TELESCOPING MAGNETIC PICK-UP AND FLASHLIGHT

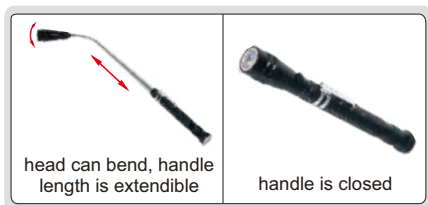

7163-1



- For illumination and pick up steel parts in hidden areas
- Head can bend
- Telescoping handle, made of stainless steel
- Magnetic head and end
- With four LR44 batteries

Code	Magnetic force of the end	Magnetic force of the head	Flashlight range	Battery life	Length
7163-1	4kgf	2kgf	3m	8h	172~568mm

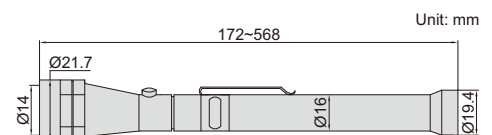

## TELESCOPING MAGNETIC PICK-UP

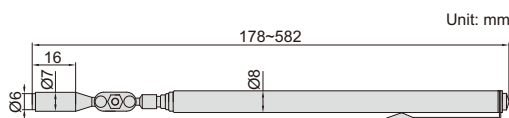

- Pick up steel parts from hidden areas
- Rotation of magnetic head: 360°
- Length of handle is adjustable, handle is made of stainless steel



7161-1

Code	Size of magnetic tip	Magnetic force	Length
7161-1	Ø6mm	0.45kgf	178~582mm

## FLEXIBLE PICK-UP AND FLASHLIGHT

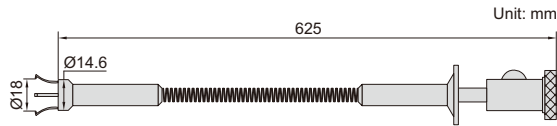

- To illumination, to pick up parts from hidden areas, or to pick up steel parts
- Flexible spring rod, made of stainless steel
- Three LR44 batteries

Code	Magnetic force	Flashlight range	Battery life
7164-1	0.9kgf	1m	24h

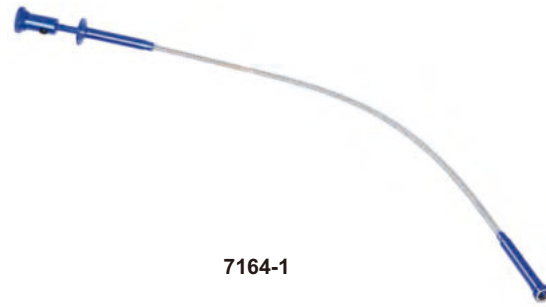

7164-1

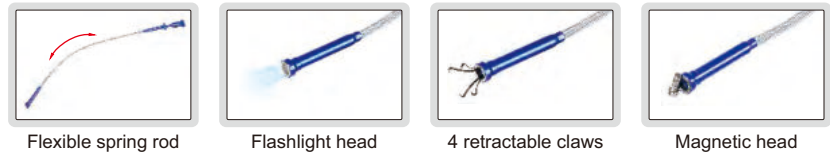

## MULTIPURPOSE VIDEOSCOPE



### MAIN UNIT (without cable)

Code	VSP-201
Function	take picture, take video
File format	picture: JPG, video: AVI
Image process	brightness, contrast
Memory	32GB
Output	TV, USB
Power supply	rechargeable battery (for 4 hours working)
Dimension	260×170×65mm
Weight	1.2kg

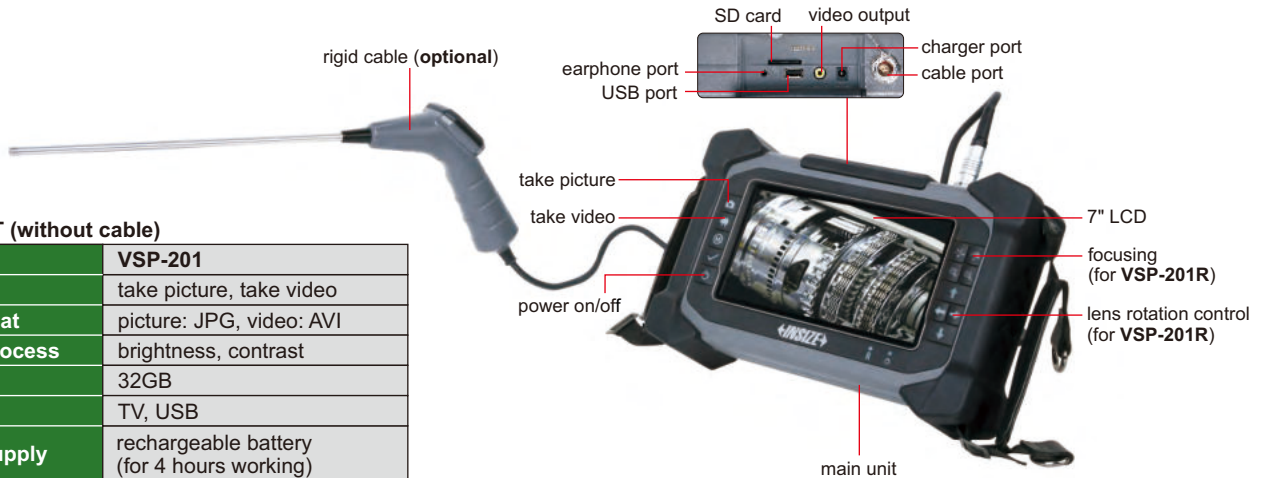

19

20

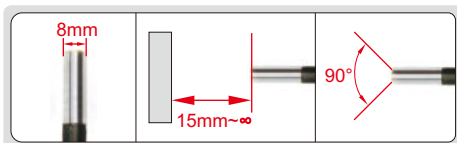

diameter (ØD) focus distance (F) angle of view (θ)

### FOUR-DIRECTION CABLE (FRONT VIEW)

Code	VSP-201D	
Cable	length	3m
	type	tungsten wire weaved cable
Lens	diameter (ØD)	8mm
	focus distance (F)	15mm~∞
	angle of view (θ)	90°
	illumination	6 pcs LED
	pixel	1M
	resolution	1280×720
dust/waterproof	IP67	



bend in any direction 360° swivel in clockwise and counter-clockwise bend within 120°



To be continued

Continued from previous page

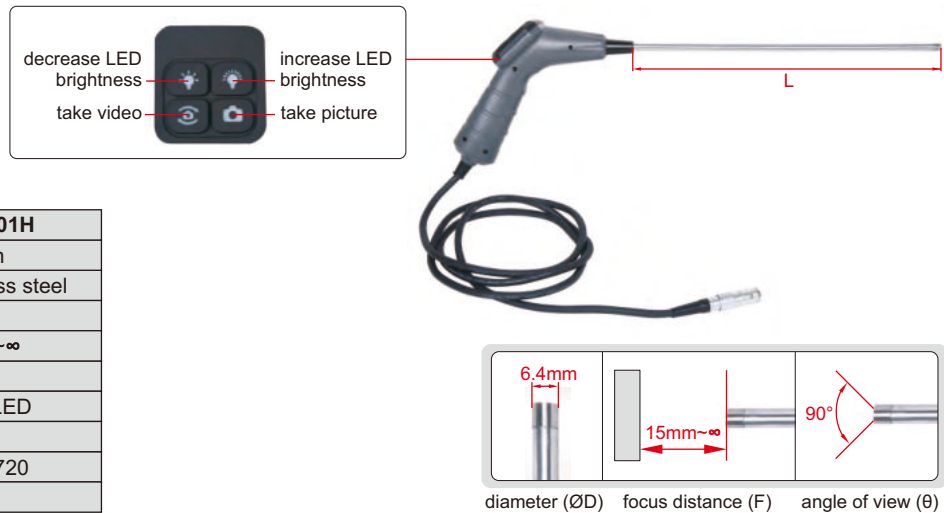

### RIGID CABLE

<b>Code</b>	<b>VSP-201H</b>	
<b>Cable</b>	length	250mm
	type	stainless steel
<b>Lens</b>	diameter (ØD)	6.4mm
	focus distance (F)	15mm~∞
	angle of view (θ)	90°
	illumination	6 pcs LED
	pixel	1M
	resolution	1280×720
	dust/waterproof	IP64

### ROTATING LENS CABLE

<b>Code</b>	<b>VSP-201R</b>	
<b>Cable</b>	length	30m
	type	high strength glass fibre
<b>Lens</b>	diameter (ØD)	40mm
	focus distance (F)	3mm~∞
	angle of view (θ)	100°
	illumination	12 pcs LED
	pixel	0.3M
	resolution	800×480
	dust/waterproof	IP67
lens control	motorized	

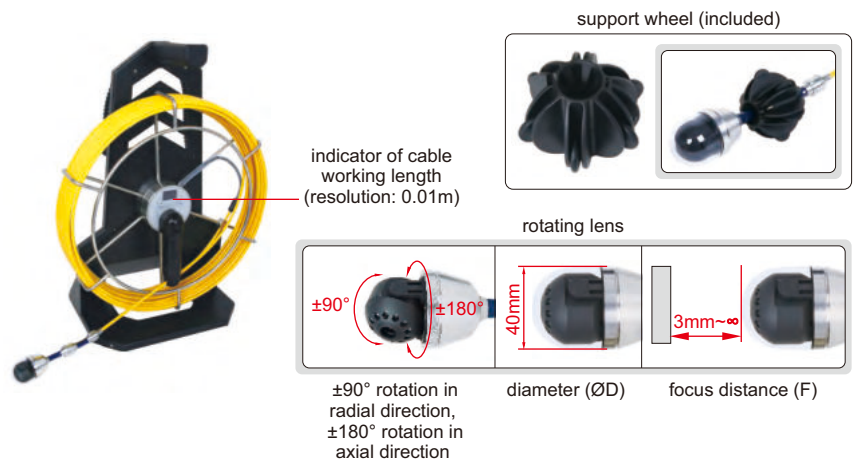

### WIDE-ANGLE LENS CABLE

<b>Code</b>	<b>VSP-201W</b>	
<b>Cable</b>	length	30m
	type	high strength glass fibre
<b>Lens</b>	diameter (ØD)	24mm
	focus distance (F)	10mm~∞
	angle of view (θ)	100°
	illumination	12 pcs LED
	pixel	0.3M
	resolution	800×480
dust/waterproof	IP67	

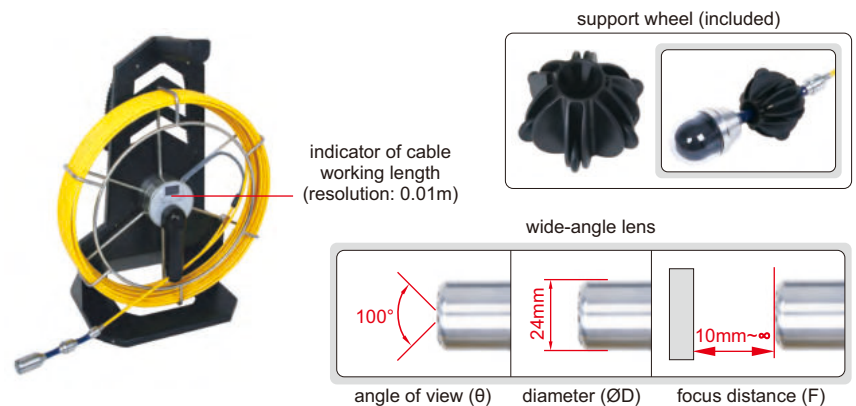

### ADJUSTABLE SUPPORT

<b>Code</b>	<b>Working diameter (ØD)</b>	<b>Remark</b>
<b>VSP-201-R200</b>	60~200mm	for VSP-201R or VSP-201W

